

**Rhinology
Rhinologie
Rhinologie
Rinología
Rinologia**

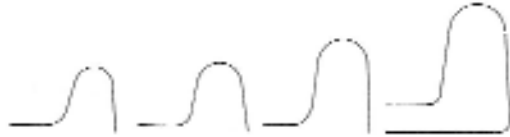

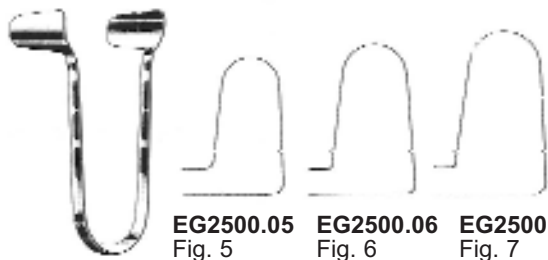

EG2500.01 Fig. 1 **EG2500.02** Fig. 2 **EG2500.03** Fig. 3 **EG2500.04** Fig. 4



THUDICHUM
EG2500.01 - EG2500.07



EG2600.01
 Fig. 1



EG2600.02
 Fig. 2



EG2600.03
 Fig. 2



VOLTOLINI
EG2600.01 - EG2600.03



EG2012.01
 Fig. 1

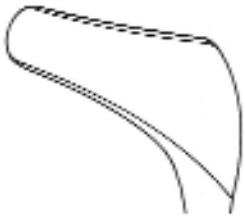

EG2012.02
 Fig. 2

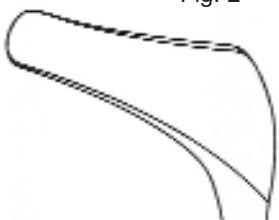

EG2012.03
 Fig. 3



HARTMANN-HALLE
EG2012.01 - EG2012.03
 15 cm



Mod. Wien • Vienna •
 Vienne • Viena

Baby • Bébé **EG2112.01**
 Kind • child • enf. • niño • bamb. **EG2112.02**
 Erw. • Adult. **EG2112.03**



Mod. Wien • Vienna
 Vienne • Viena
EG2113.03
 leichtes Modell
 lightweight
 mod. léger
 mod. ligero
 mod. leggero



TIECK-HALLE
EG2116.13
 13,5 cm



KILLIAN
EG2210.35 - EG2210.90
 13,5 cm

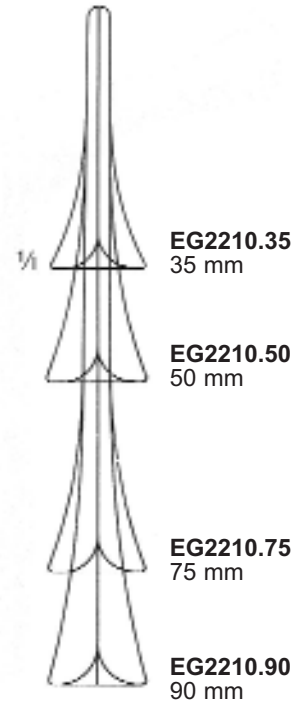

COTTLE
EG2214.35 - EG2214.90
 14 cm



COTTLE
EG2216.35 - EG2216.90
 schwarz • black • noirs
 negros • neri
 14 cm

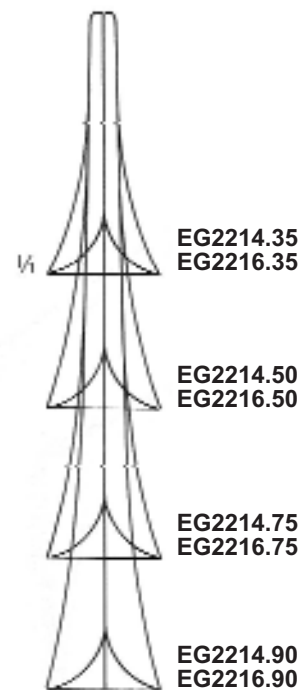



YANKAUER
EG2311.19
19 cm



MICHEL
EG2319.12 - EG2319.18
25 cm



EG2319.12
12 mm



EG2319.14
14 mm



EG2319.16
16 mm



EG2319.18
18 mm

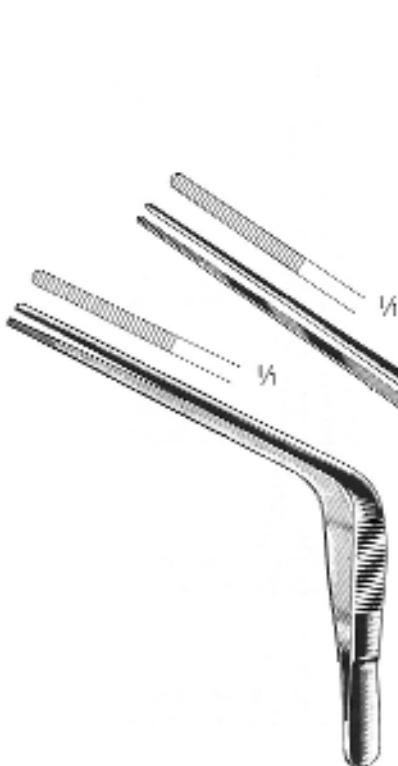

TROELTSCH
EG2511.15
15 cm

TROELTSCH
EG2511.18
18 cm



TROELTSCH
EG2514.20
20 cm

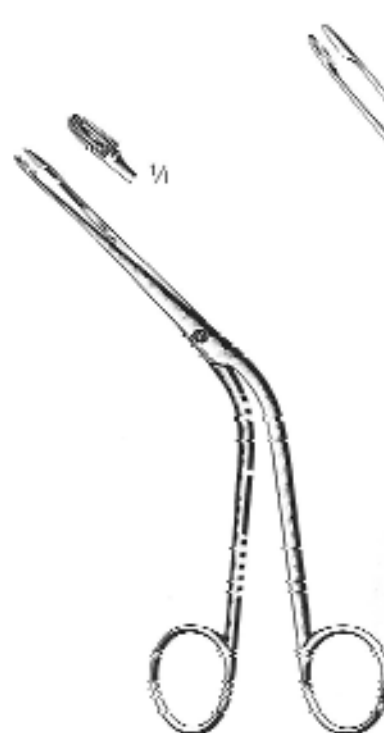

HARTMANN
EG2611.16
16 cm



HARTMANN
EG2611.20
20 cm

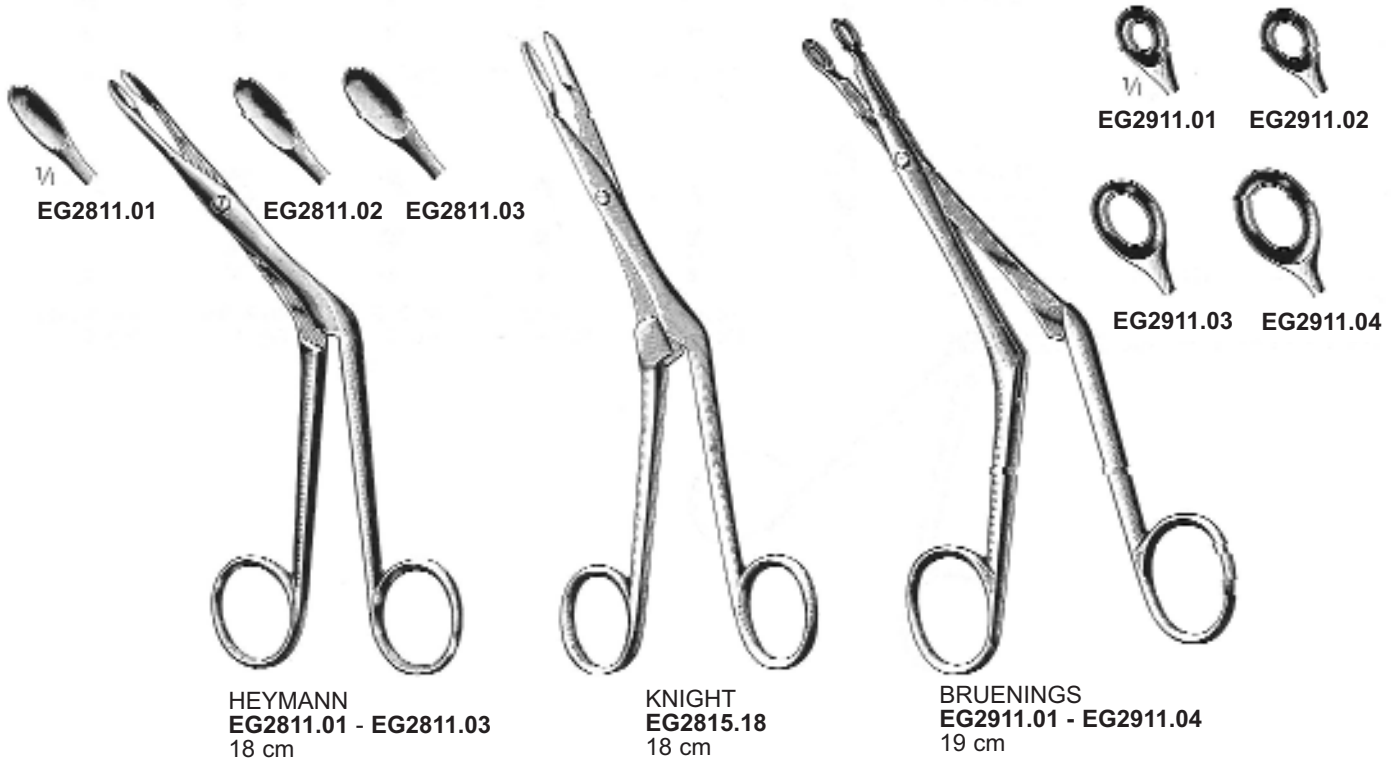
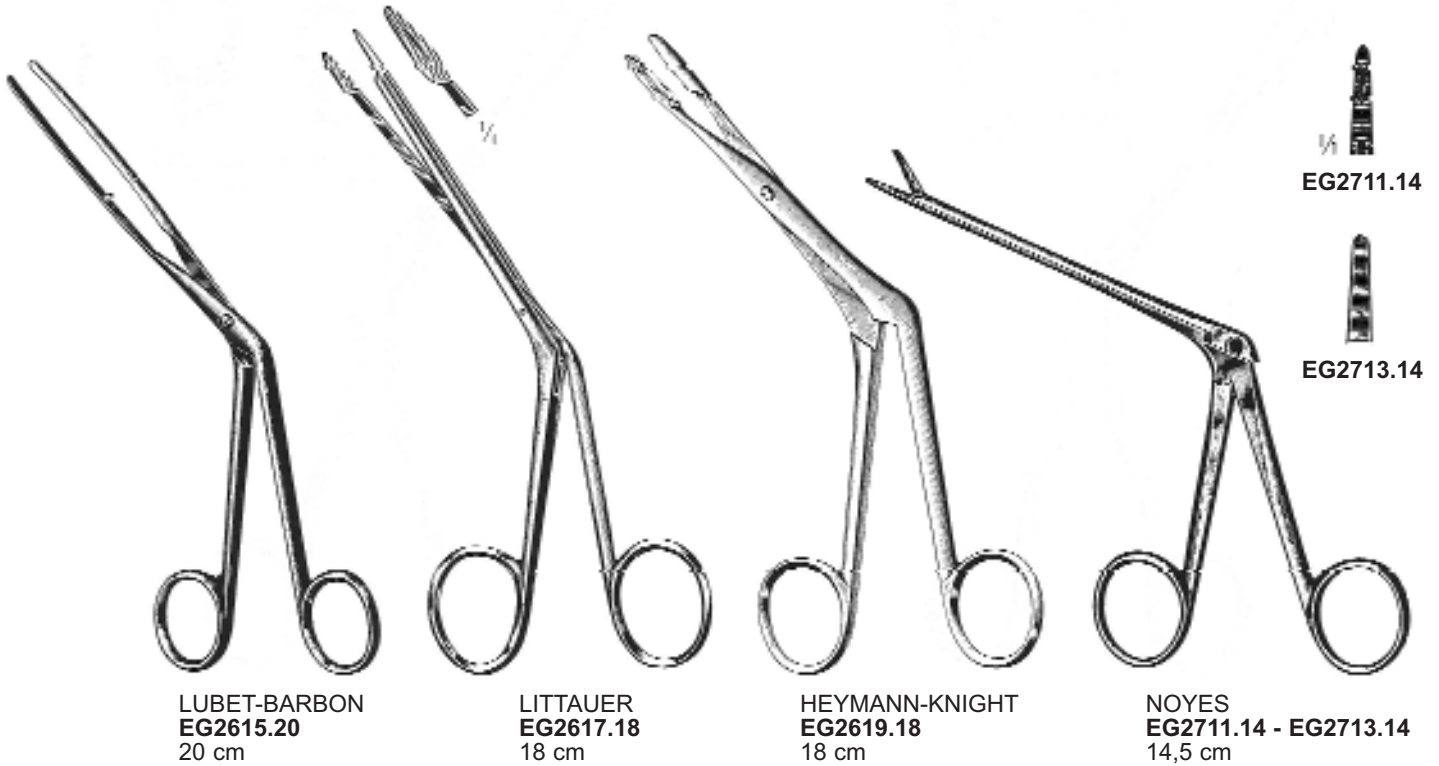

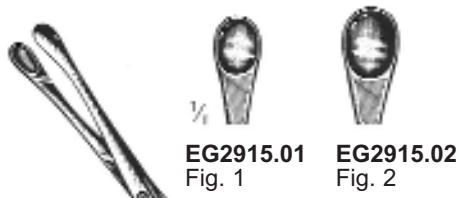

LUC
 EG2915.01 - EG2915.02
 19 cm



LUC
 EG2917.01 - EG2917.02
 19 cm

without neck
 ohne Hals
 sans cou
 sin cuello
 senza collo

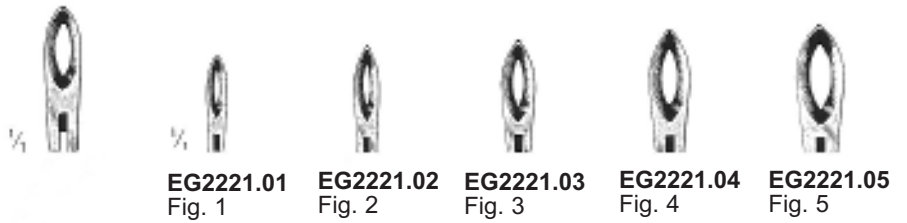

with neck
 mit Hals
 avec cou
 con cuello
 con collo

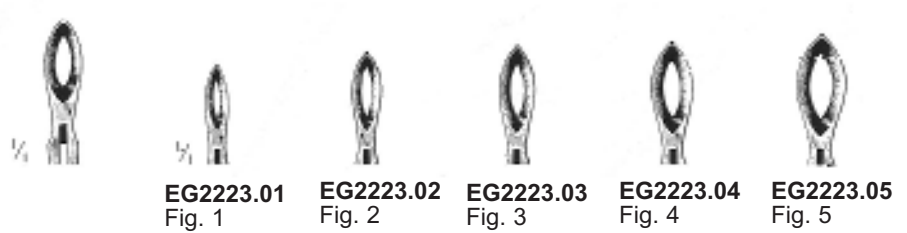

WEIL-BLAKESLEY
 EG2221.01 - EG2223.05

Nasal Cutting Forceps
Scharfe Nasenzangen
Pincas coupantes nasales
Pinzas cortantes nasales
Pinze taglianti nasali

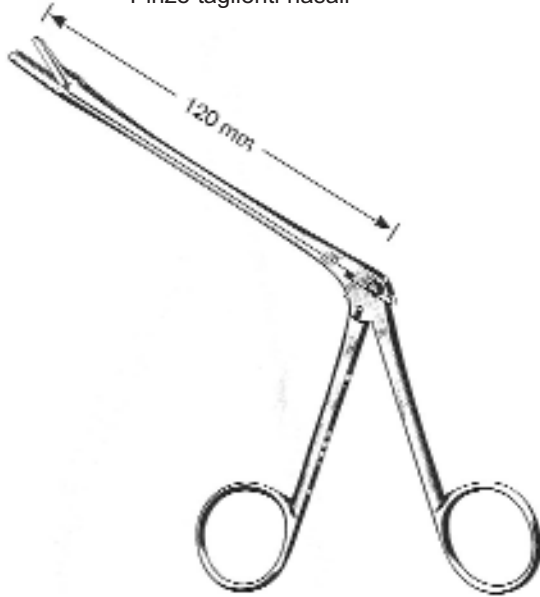

EG2321.01- EG2327.03
19 cm



STRUYCKEN
EG2321.01
Fig. 1



STRUYCKEN
EG2321.02
Fig. 2



EG2327.01
5 mm



EG2327.02
7 mm



EG2327.03
9 mm



MYLES



EG2325.05



EG2325.07



EG2325.09



EG2325.11



HARTMANN

Septum Crushing Forceps
Septum- Quetschzange
Pince à éraiser la cloison
Pinza para magullar tabique
Pinza per ammaccare il setto



RUBIN
EG2521.21
21 cm



mm x mm	KERRISON
3 x 3	EG2033.03
4 x 4	EG2033.04
5 x 5	EG2033.05
6 x 6	EG2033.06

17 cm



EG2035.01
3, 5 mm



EG2035.02
3, 5 mm



HAJEK-KOFLER
EG2035.01 - EG2035.02

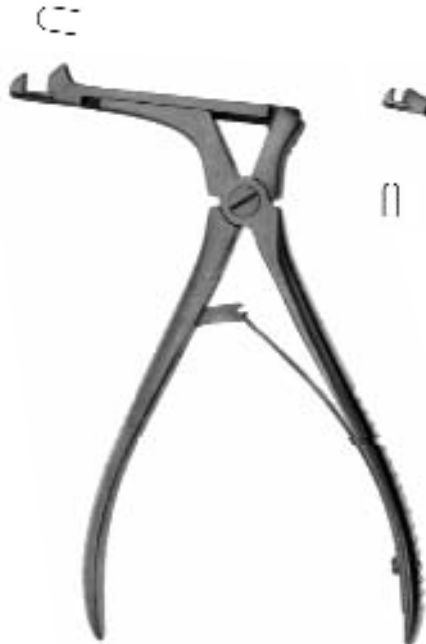

mm	CITELLI
1,0	EG2131.10
2,5	EG2131.25
4,0	EG2131.40



BEYER
EG2135.20
2,0 mm



HAJEK-CLAUS
EG2230.20
20 mm



MIDDLETON-JANSEN
EG2233.19
19 cm



MIDDLETON-JANSEN
EG2235.19
19 cm

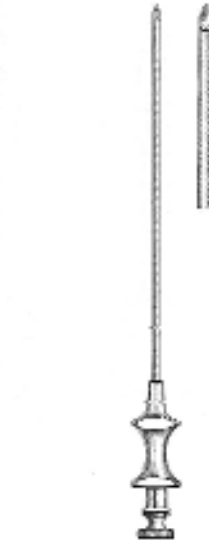

∅ mm	LICHTWITZ
1,5	EG2430.15
1,8	EG2430.18
2,0	EG2430.20

Luer-Lock
10 cm



KILLIAN
EG2431.03
14 cm/3 mm ∅



KRAUSE
EG2531.26
26 cm



WILDE
EG2532.24
24 cm



WILDE
EG2535.03
0,3 mm



JOSEPH
 EG2730.16 - EG2733.16



EG2730.16 EG2731.16
 stumpf • blunt • mousses
 romos • smussi



EG2732.16 EG2733.16
 spitz • pined • pointus
 puntiagudos • acuti



FREER
 EG2734.15
 15 cm



FREER
 EG2735.19
 19cm



JOSEPH
 EG2736.16
 16 cm



CONVERSE
 EG2739.16
 16 cm



CONVERSE
 EG2830.15
 15 cm



EG2832.15



COTTLE
 EG2834.15



EG2835.15

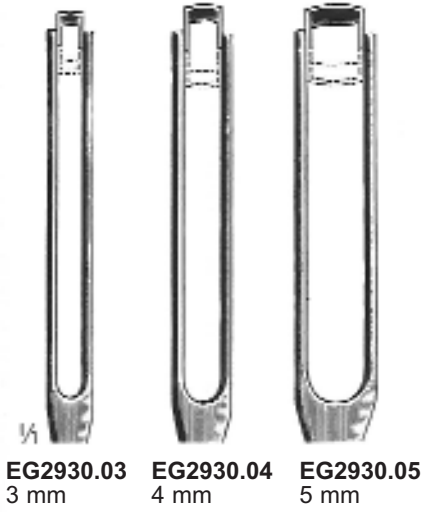

EG2930.03 3 mm
EG2930.04 4 mm
EG2930.05 5 mm

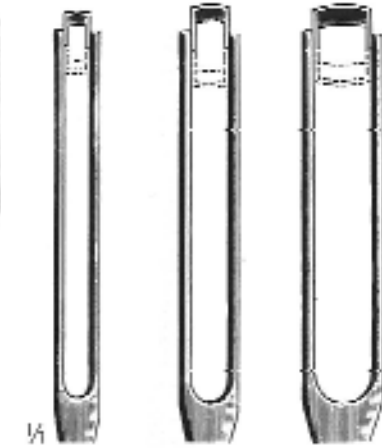

EG2932.03 3 mm
EG2932.04 4 mm
EG2932.05 5 mm



BRUENINGS
EG2938.16
 16,5 cm

BALLENGER
EG2930.03 - EG2932.05
 20 cm

Septum Elevators
 Septum-Elevatorien
 Elévateurs pour la cloison nasale
 Elevadores para tabique
 Elevatori per setto

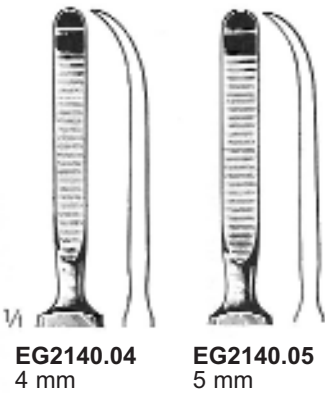

EG2140.04 4 mm
EG2140.05 5 mm

McKENTY
EG2140.04 - EG2140.05
 15 cm



ROGER
EG2143.19
 19 cm



FREER
EG2145.18
 18 cm



FREER
EG2147.19
 19 cm



FREER
EG2149.19
 19 cm



COTTLE
EG2241.23
23 cm



COTTLE
EG2243.22
22 cm



JOSEPH
EG2245.16
16 cm



COTTLE
EG2245.19
19cm



KILLIAN
EG2246.22
19cm



HAJEK-BALLENGER
EG2248.21
22 cm



BALLENGER
EG2340.22
2 cm



FREER
EG2540.04
4 mm



FREER
EG2541.04
4 mm



COTTLE
 EG2544.04 - EG2544.12
 18 cm



COTTLE
 EG2545.06
 18 cm/6 mm

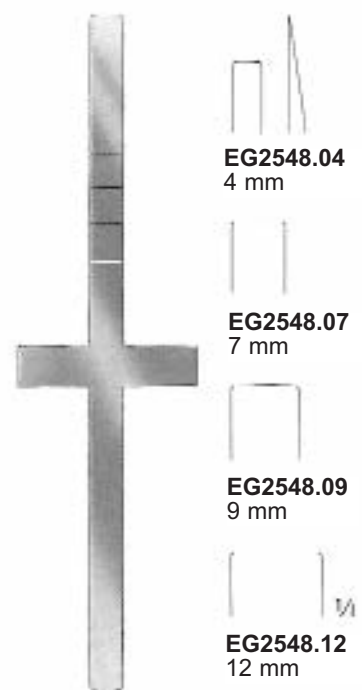

COTTLE
 EG2548.04 - EG2548.12

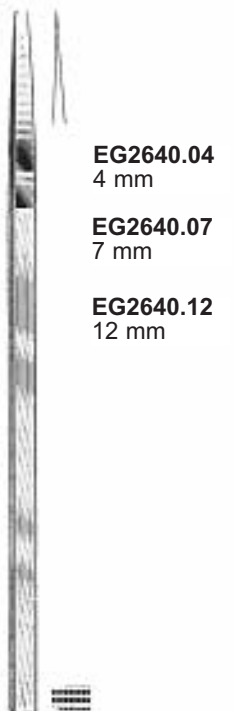

COTTLE
 EG2640.04 - EG2640.12
 18 cm

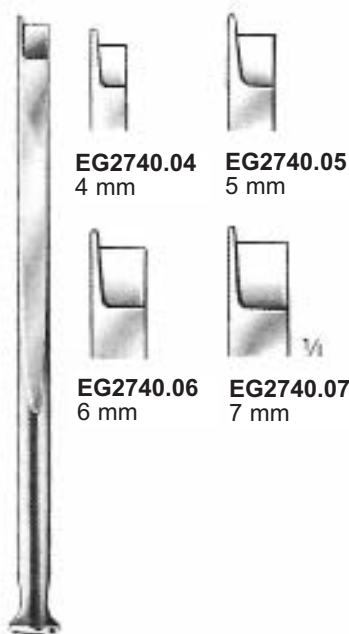

FOMON
 EG2740.04 - EG2740.07
 17 cm

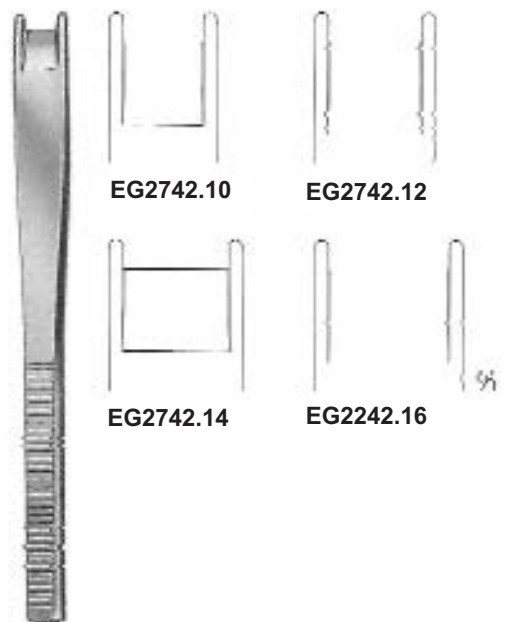

FOMON
 EG2742.10 - EG2742.16

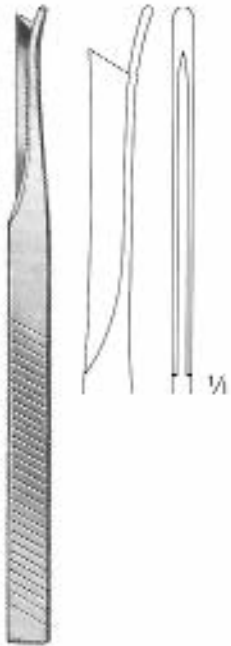

SILVER
EG2743.01
18 cm

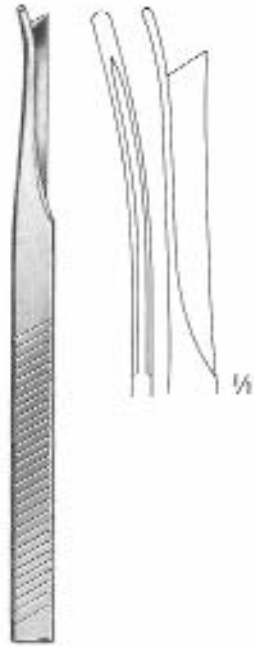

SILVER
EG2743.02
18 cm

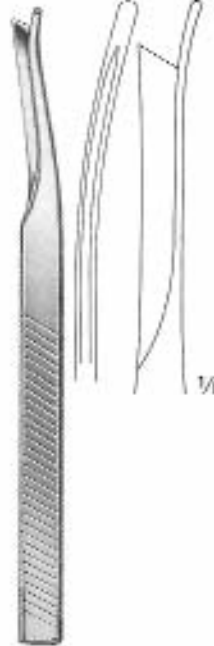

SILVER
EG2743.03
18 cm



KILLIAN-CLAUS
EG2842.05
17 cm/5 mm



mm	HAJEK
4	EG2844.04
6	EG2844.06
8	EG2844.08



WEST
EG2846.16
16 cm



WEST
EG2847.16
16 cm



FREER
EG2849.16
6 mm



JOSEPH
EG2052.16
16 cm

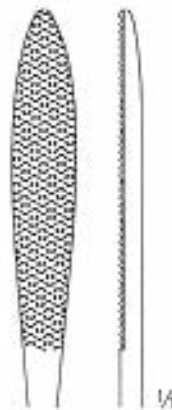

MALTZ
EG2054.18
18 cm

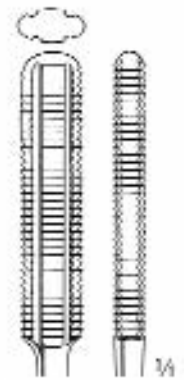



EG2057.18



EG2057.19

WIENER
EG2057.18 - EG2057.19
18 cm



EG2151.21



EG2153.21

WIENER (AUFRICHT)
EG2151.21 - EG2153.21
21 cm



EG2154.16
fein • fine
fina



EG2156.16
grob • coarse • gruesa
entellure grosse
dentellatura grossa

JOSEPH (LEWIS)
EG2154.16 - EG2156.16
18 cm

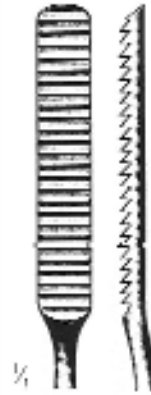

MALTZ (COTTLE)
EG2158.21
21 cm

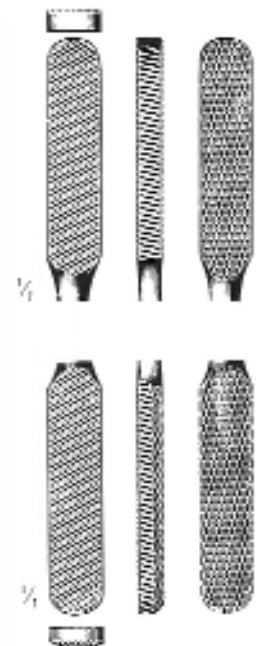

FOMON
EG2250.21
21 cm



FOMON
20 cm TC

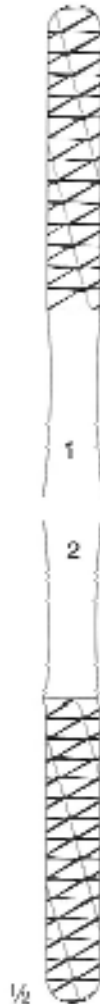

Fig. 1/2

EG2252.01



Fig. 3/4

EG2252.03



Fig. 5/6

EG2252.05



Fig. 7/8

EG2252.07



Fig. 9/10

EG2252.09

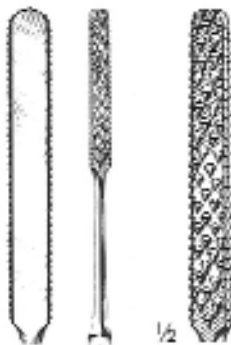

Fig. 1



Fig. 2

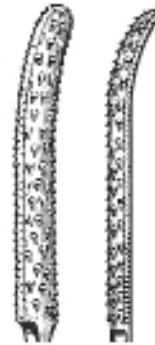

Fig. 3



GALLAHER

EG2256.16

EG2257.16

EG2259.16

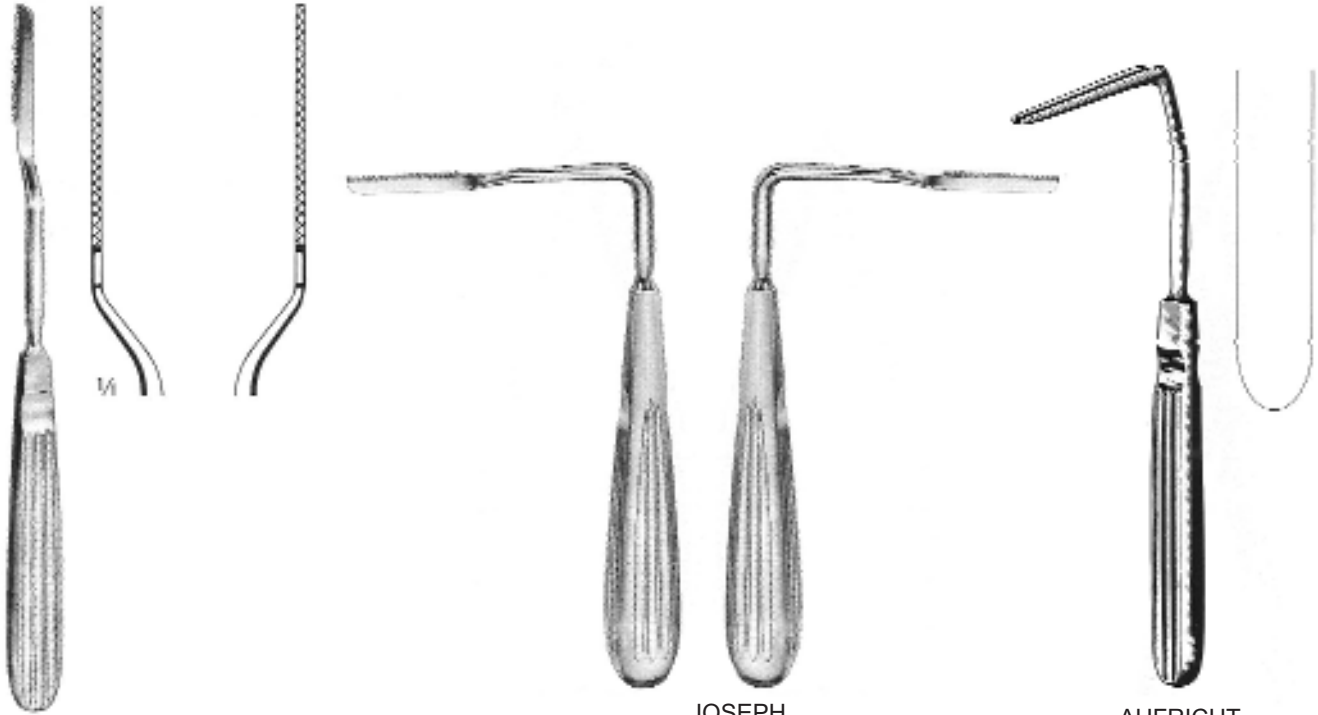

JOSEPH
EG2355.01 17 cm EG2355.02

AUFRICHT
EG02551.16
19 cm

JOSEPH
19 cm
EG2352.19 links • left
à gauche
izquierda
a sinistra
EG2354.19 rechts • right •
á droite
derecha
a destra

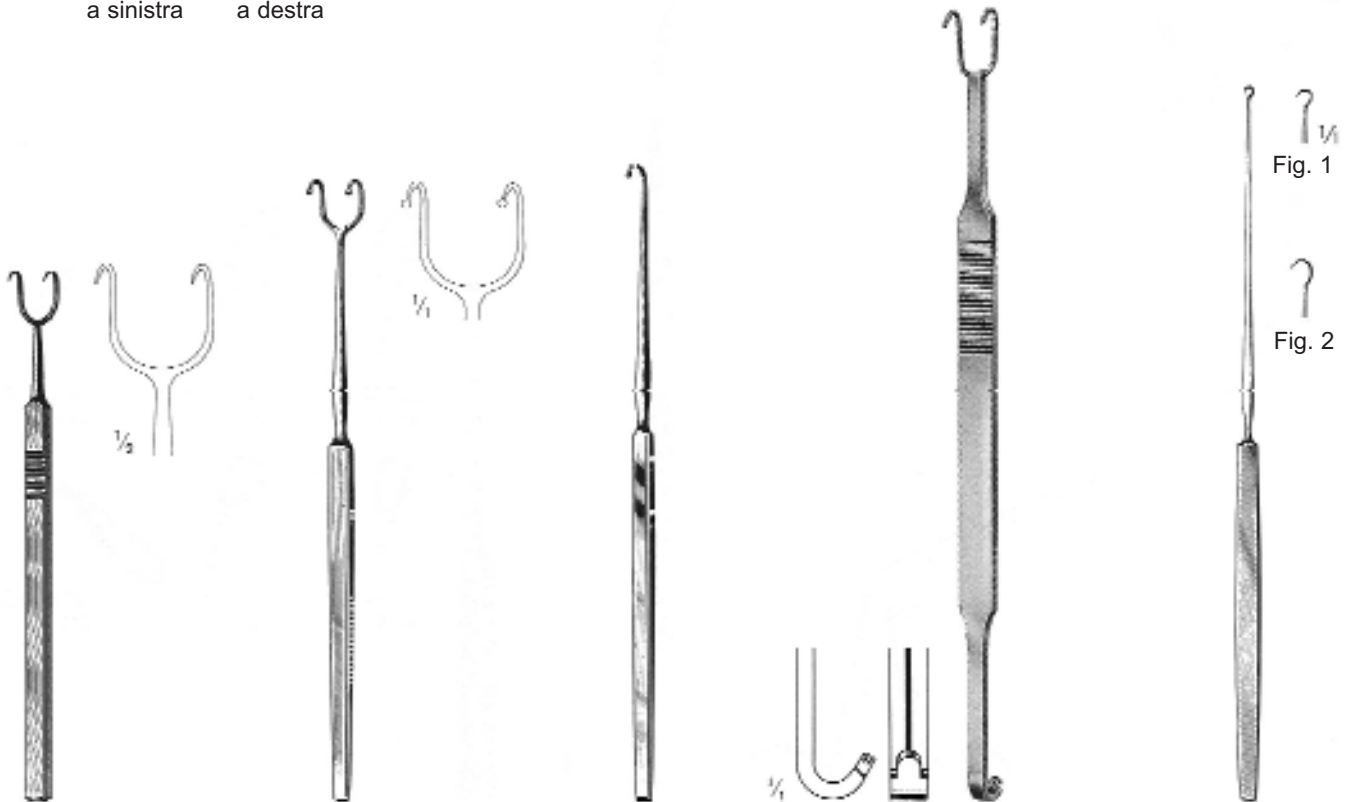

COTTLE
EG2556.14

FOMON
EG2556.16

FOMON
EG2557.17

COTTLE-NEIVERT
EG2559.20

Fig. 1
Fig. 2
GILLIES
EG2650.18
EG2652.18
18 cm



ASCH
EG2751.23
23 cm

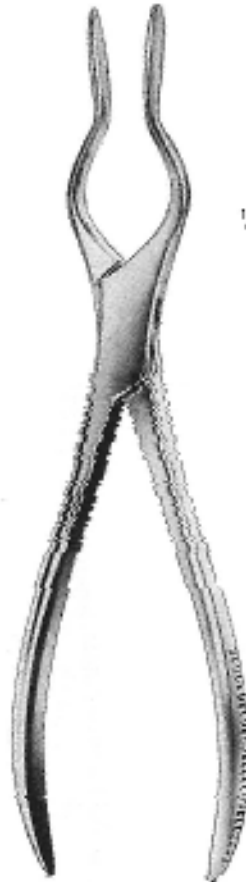

EG2752.23
straight
gerade
droite
recta
retta

EG2753.23
left
links
à gauche
izquierda
a sinistra

EG2755.23
right
rechts
à droite
derecha
a destra

WALSHAM
EG2752.23 - EG2755.23
23 cm



JATHO
EG2955.15



FAULKNER
EG2061.21
21 cm

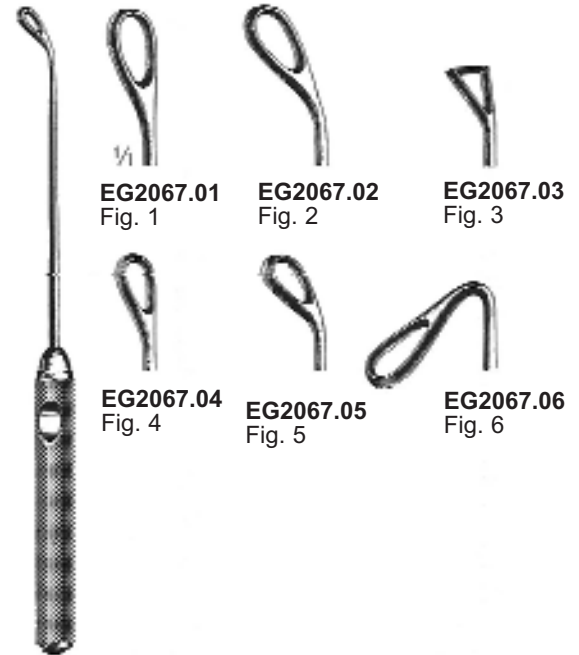

EG2067.01
Fig. 1

EG2067.02
Fig. 2

EG2067.03
Fig. 3

EG2067.04
Fig. 4

EG2067.05
Fig. 5

EG2067.06
Fig. 6

COAKLEY
EG2067.01 - EG2067.06
17 cm



EG2260.01
Fig. 1



EG2260.02
Fig. 2



BECKMANN
EG2260.01 - EG2260.06
22 cm



EG2260.03
Fig. 3



EG2260.04
Fig. 4



EG2260.05
Fig. 5



EG2260.06
Fig. 6



BARNHILL
EG2360.01 - EG2360.04
21 cm



EG2360.01
Fig. 1



EG2360.02
Fig. 2



EG2360.03
Fig. 3



EG2360.04
Fig. 4



EG2461.01
Fig. 1



EG2461.02
Fig. 2



EG2461.03
Fig. 3

Spare blades, perforated
Ersatzklingen, gelocht
Lames de rechange, perforées
Hojas de repuesto, perforadas
Lame di ricambio, forate

Fig.	
1	EG2462.01
2	EG2462.02
3	EG2462.03



St. CLAIR-THOMSON
EG2366.01 - EG2366.04
21 cm

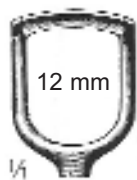

EG2366.01
Fig. 1



EG2366.03
Fig. 3



EG2366.02
Fig. 2

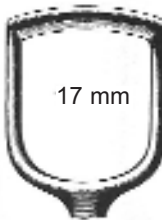

EG2366.04
Fig. 4



LAFORCE
EG2461.01 - EG2641.03
25 cm

