

**Neurosurgery, Laminectomy
Neurochirurgie, Laminektomie
Neurochirurgie, Laminectomie
Neurocirugía, Laminectomía
Neurochirurgia, Laminectomia**

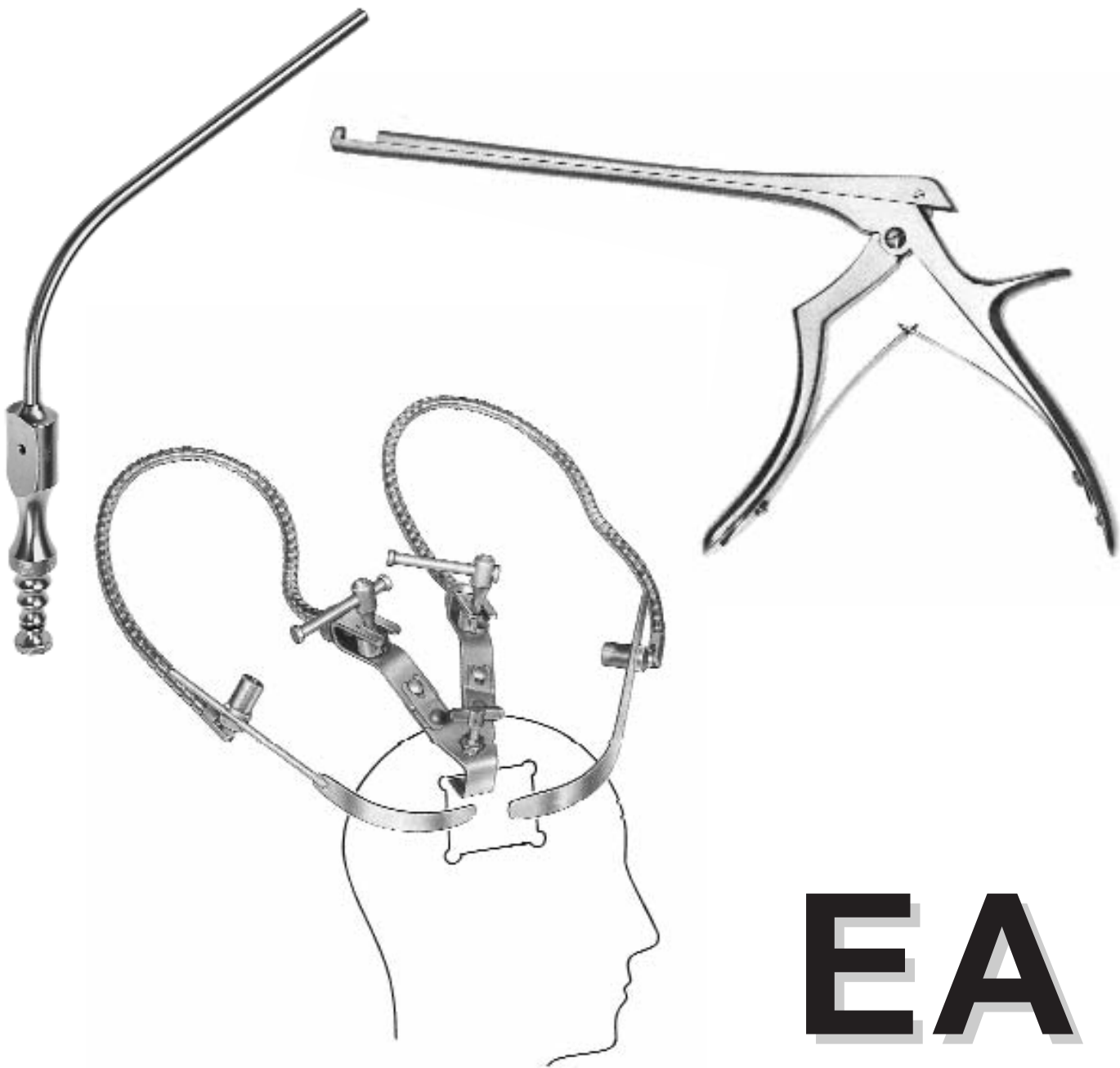

EA



cm McKenzie
15 EA2101.15
19 EA2101.19

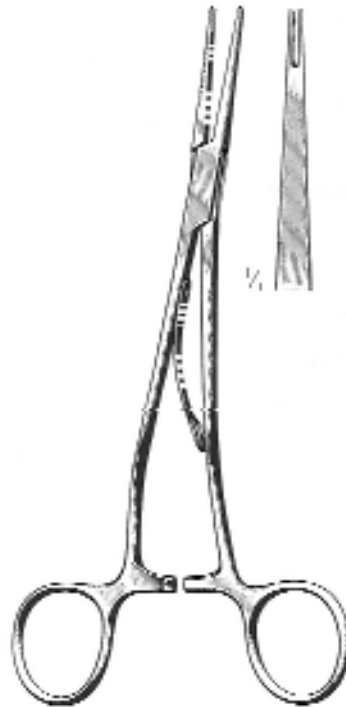

cm McKenzie
15 EA2103.15
19 EA2103.19

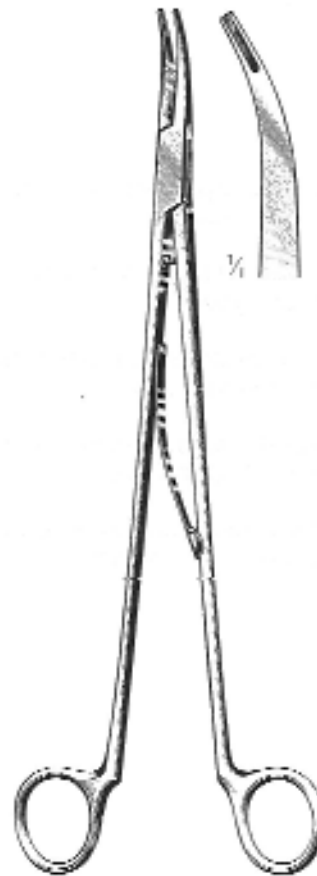

cm SMITHWICK
23 EA2105.23
26 EA2105.26

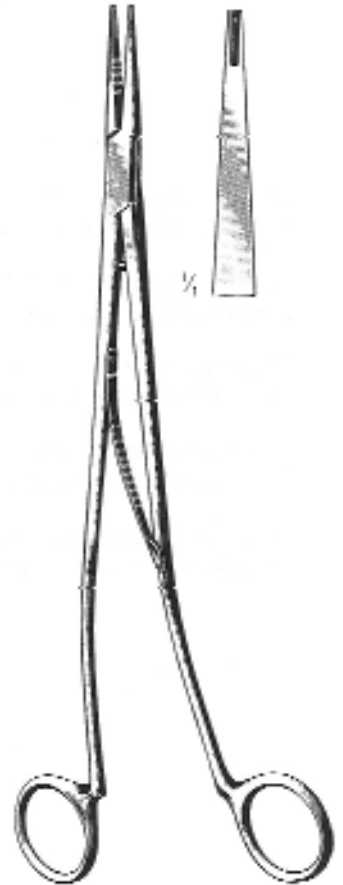

cm SWEET
23 EA2107.23
26 EA2107.26



OLIVECRONA-TOENNIS
EA2109.14

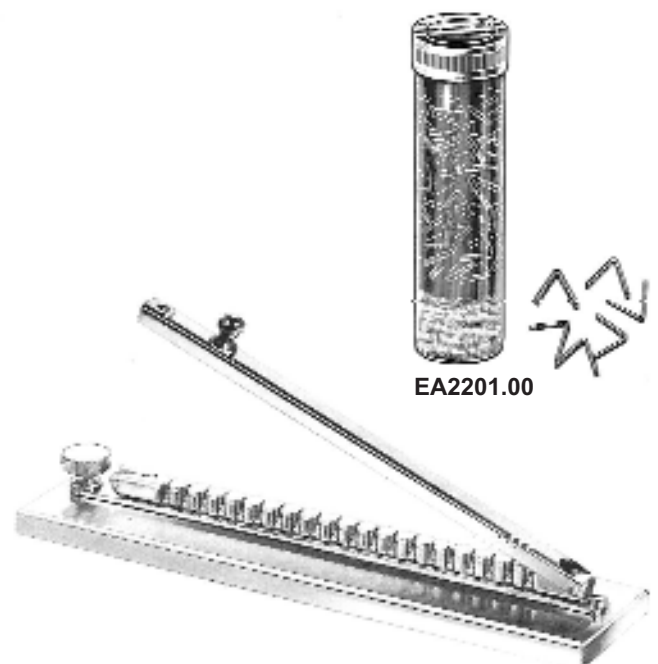

EA2200.00
148x40x6 mm



**CRUTCHFIELD
EA2205.01**



**CRUTCHFIELD
EA2205.02**



**EA2206.35
3,5 mm ø**



**EA2206.50
5 mm ø**

Scalp Hemostasis Clip, Applying Forceps
 Kopfhautklammer, -anlegezange
 Pince hémostatique pour le cuir chevelu, pince á poser
 Pinza hermostática para cuero cabelludo, pinza para poner
 Pinza emostatica per il cuoio capelluto, pinza per applicare e togliere



**RANEY
EA2207.00**



**RANEY
EA2208.00**

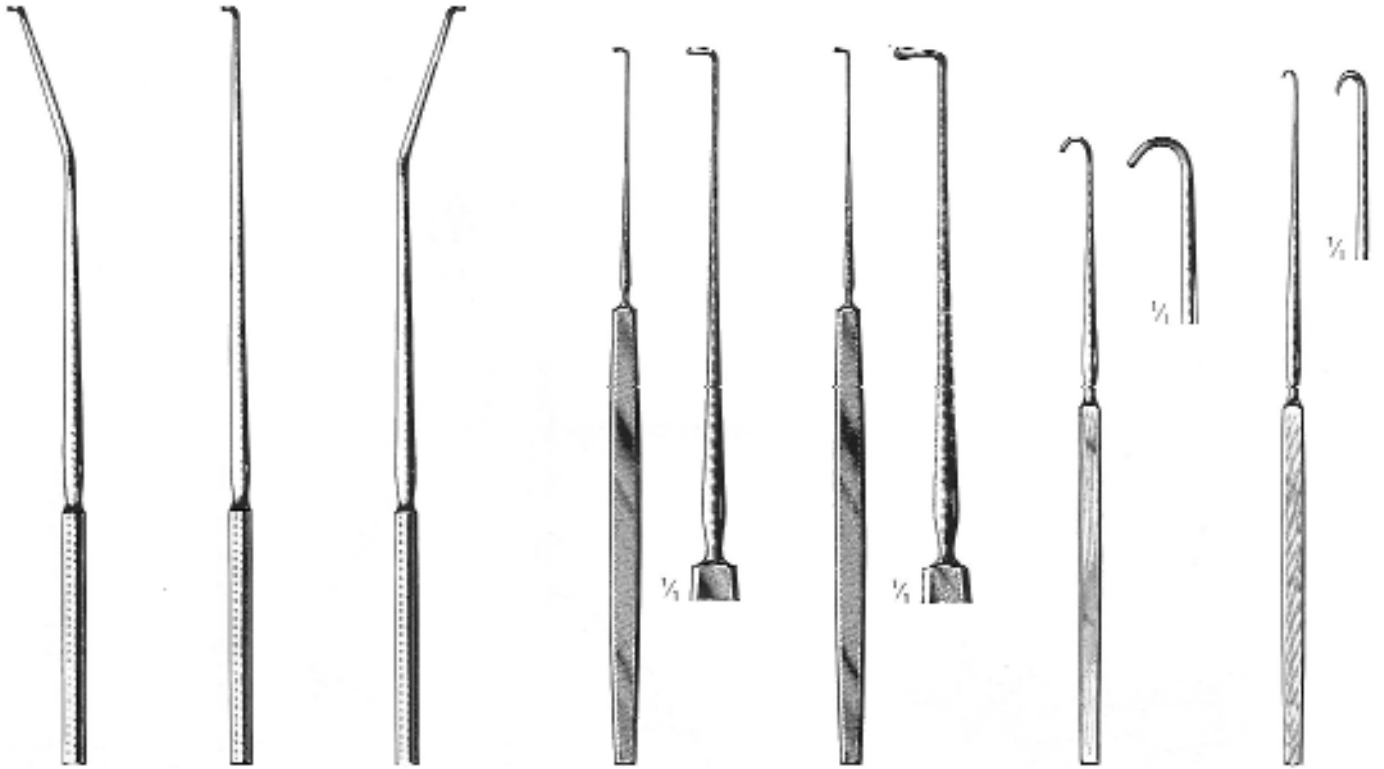

DANDY
EA2501.20
 20 cm

DANDY
EA2502.20
 20 cm

DANDY
EA2503.20
 20 cm

CUSHING
EA2506.28
 28 cm

CUSHING
EA2508.28
 28 cm

GRAHAM
EA2601.16
 16,5 cm

SACHS
EA2604.18
 18,5 cm



ADSON
EA2608.20
 20 cm

ADSON
EA2609.20
 20 cm

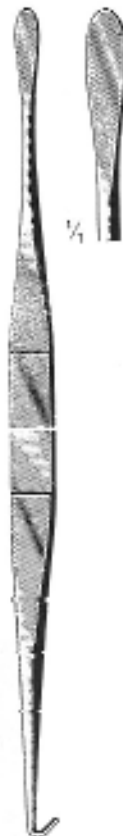

SMITHWICK
EA2700.29
 29 cm

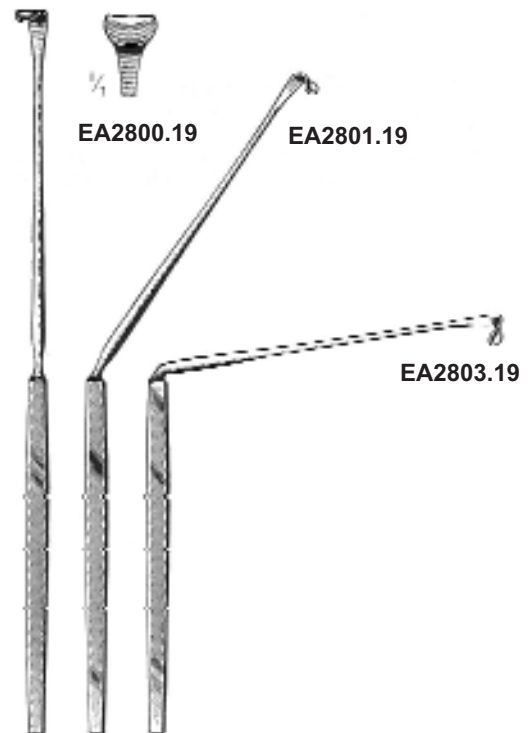

LOVE
EA2800.19 - EA2803.19



De MARTEL
EA2900.33
 33 cm

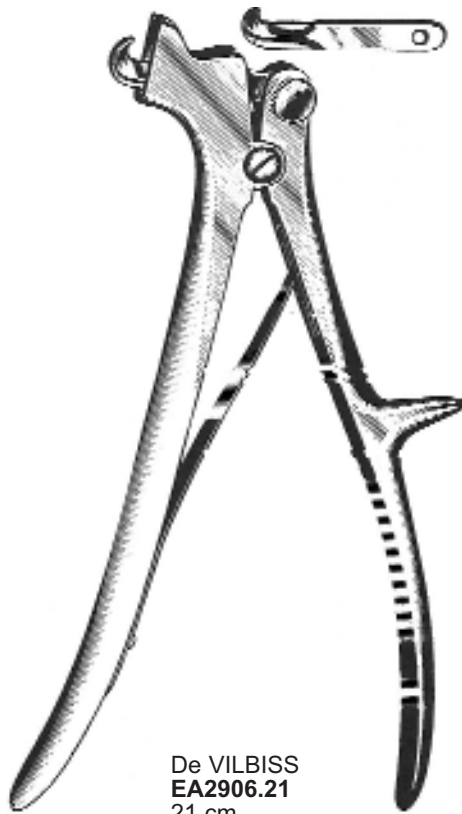

De VILBISS
EA2906.21
 21 cm

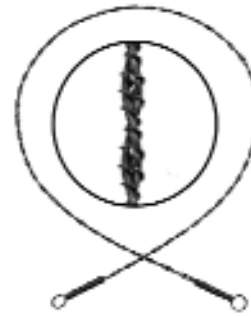

cm	OLIVECRONA
30	EA2902.30
40	EA2902.40
50	EA2902.50
60	EA2902.60
70	EA2902.70



GIGLI
 EA-904-00
 1 Paar
 1 pair
 1 paire
 1 par
 1 paio

Descoladores para la duramadre • Scollatori per la duramadre
 Dura-Dissektoren • Dura Dissectors • Dissecteus á duremère



TOENNIS
EA2411.25
 25 cm



SACHS
EA2413.21



SACHS
EA2415.21



MILLIGAN
EA2417.21



EA2419.22



DAVIS
EA2511.24

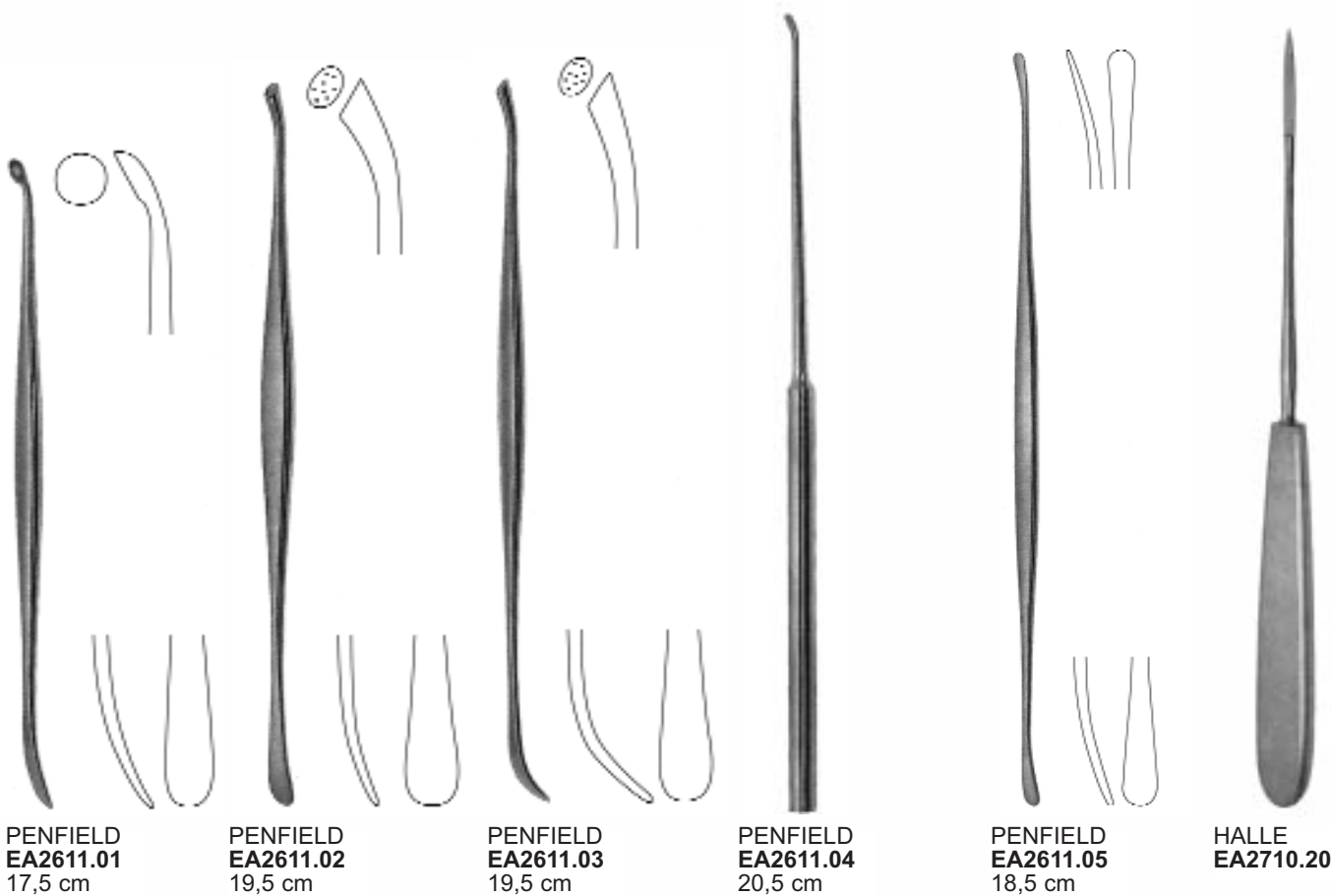

hypophyse • Pinzas para hipófisis • Pinze per ipofisi
 Hypophysenpinzetten • Hypophyseal Forceps • Pincas á

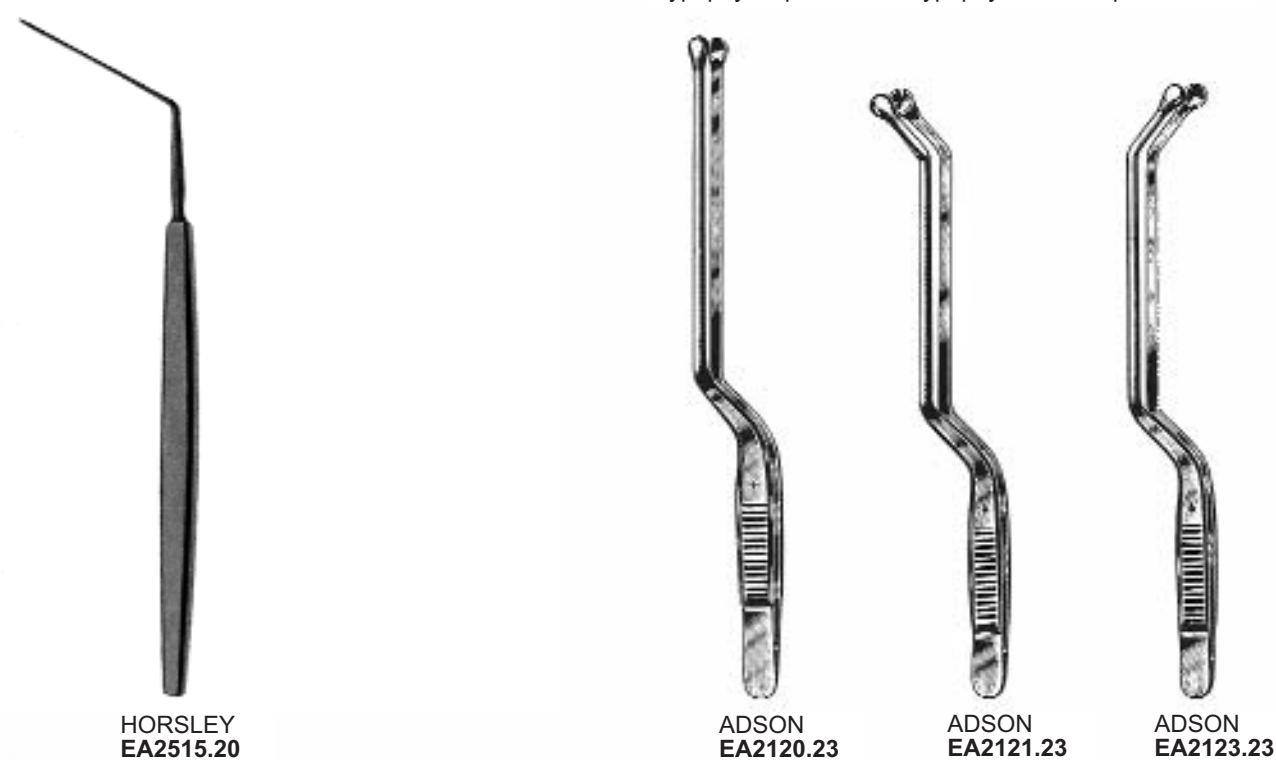

mm	CUSHING	mm	OLIVECRONA	mm	HEIFETZ	ADSON
7/9	EA2520.07	7/9	EA2523.07	8	EA2620.08	EA2920.21
11/13	EA2520.11	11/13	EA2523.11	11	EA2620.11	21cm/4 mm
15/18	EA2520.15	15/18	EA2523.15	14	EA2620.14	
18/22	EA2520.18	18/22	EA2523.18	17	EA2620.17	
	180 mm		180 mm			

Charr.	F.G.	30°	75°
6		EA2925.06	EA2927.06
7		EA2925.07	EA2927.07
8		EA2925.08	EA2927.08
9		EA2925.09	EA2927.09
10		EA2925.10	EA2927.10
11		EA2925.11	EA2927.11
12		EA2925.12	EA2927.12
15		EA2925.15	EA2927.15

FRAZIER
EA2925.06 - EA2927.12
 19 cm

Ecarteurs pour corps vertébraux •
 Wirbelkörperspreizer • Lamina Spreaders •
 Speradores para cuerpos vertebrales •
 Divaricatori per corpi vertebrali

FRAZIER
EA2928.12
 12 cm/3 mm

CLOWARD
EA2041.16

INGE
EA2045.17 - EA2045.27

EA2045.17
 17 cm

EA2045.27
 27 cm



Laminectomy Rongeurs
Laminektomie-Zangen
Pincas emporte-pièce á laminectomie
Pinzas cortantes para laminectomia
Pinze taglianti per laminectomia

CUSHING
2 mm



2x10 mm	L
EA2240.01	12,5 cm
EA2242.01	18,0 cm



2x10 mm/45°	L
EA2240.02	12,5 cm
EA2242.02	18,0 cm



2x10 mm/45°	L
EA2240.03	12,5 cm
EA2242.03	18,0 cm

LOVE-GUENWALD
3 mm



3x10 mm	L
EA2340.01	12,5 cm
EA2342.01	18,0 cm



3x10 mm/45°	L
EA2340.02	12,5 cm
EA2342.02	18,0 cm

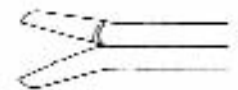

3x10 mm/45°	L
EA2340.03	12,5 cm
EA2342.03	18,0 cm

SPURLING
4 mm



4x10 mm	L
EA2440.01	12,5 cm
EA2442.01	18,0 cm



4x10 mm/45°	L
EA2440.02	12,5 cm
EA2442.02	18,0 cm



4x10 mm/45°	L
EA2440.03	12,5 cm
EA2442.03	18,0 cm

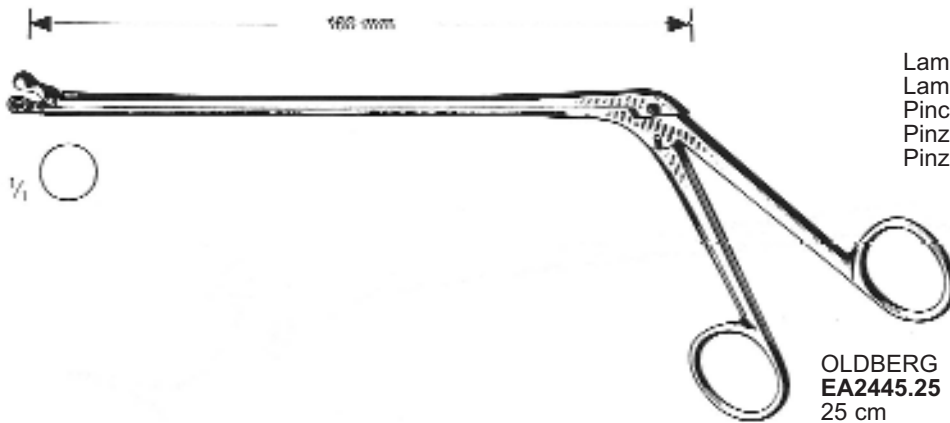

Laminectomy Rongeurs
Laminektomie-Zangen
Pinces emporte-pièce à laminectomie
Pinzas cortantes para laminectomia
Pinze taglianti per laminectomia

OLDBERG
EA2445.25
25 cm

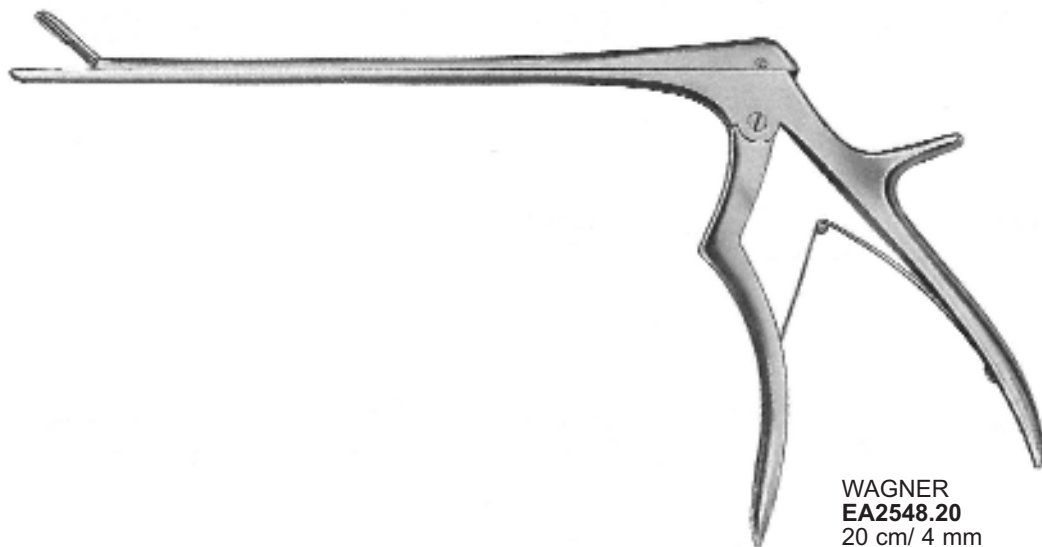
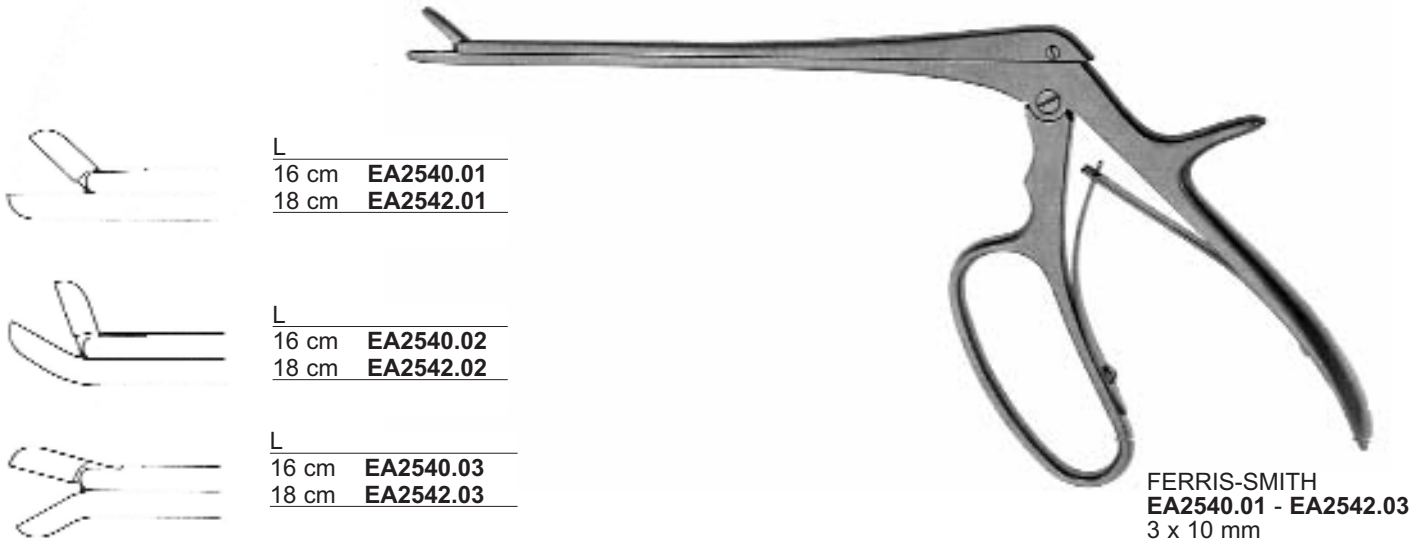

Intervertebral Disc, Rongeurs
 Bandscheiben-Stanzen
 Pincas emporte-pièce pour lames intervertébrales
 Pinzas sacabocado para discos intervertebrales
 Pinze taglianti per dischi intervertebrali

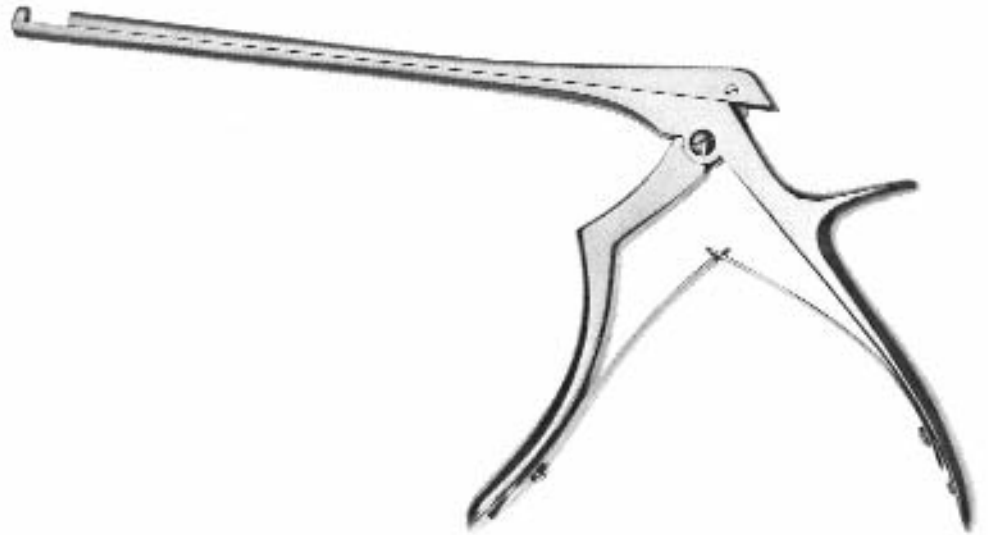

FERRIS-SMITH-Kerrison
 EA2150.01 - EA2152.05
 18 cm

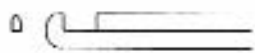

EA2150.01
 1 mm



EA2151.01
 1 mm



EA2150.02
 2 mm

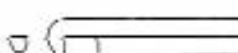

EA2151.02
 2 mm



EA2152.02
 2 mm

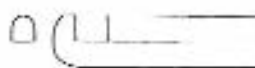

EA2150.03
 3 mm

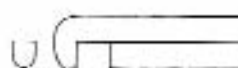

EA2151.03
 3 mm

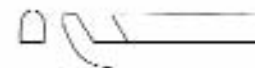

EA2152.03
 3 mm

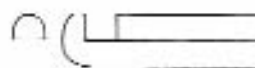

EA2150.04
 4 mm

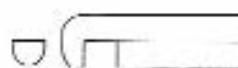

EA2151.04
 4 mm



EA2150.05
 5 mm

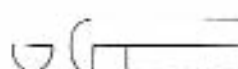

EA2151.05
 5 mm

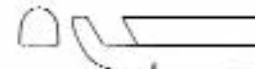

EA2152.05
 5 mm

Intervertebral Disc, Rongeurs
Bandscheiben-Stanzen
Pincas emporte-pièce pour lames intervertébrales
Pinzas sacabocado para discos intervertebrales
Pinze taglianti per dischi intervertebrali

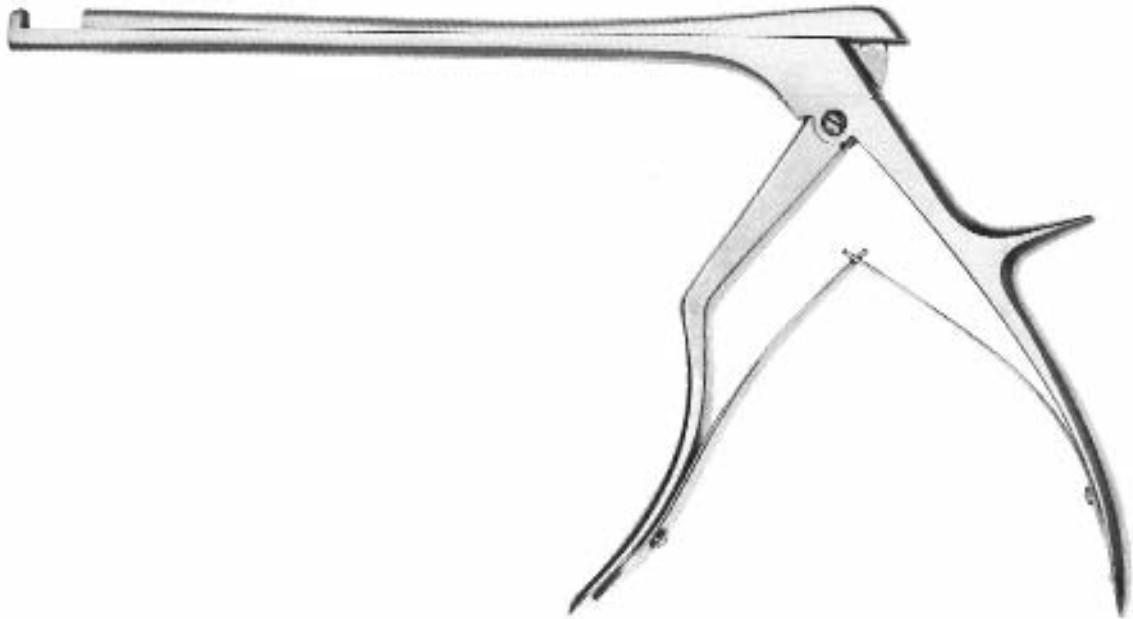

COLCLOUGH
EA2250.03 - EA2255.05

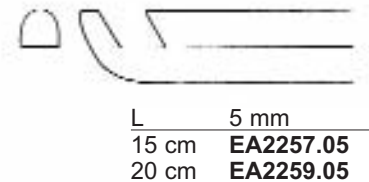
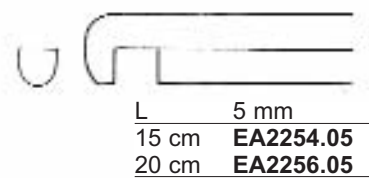
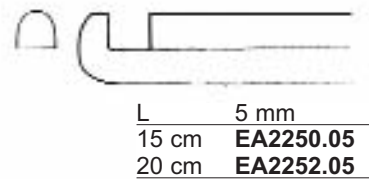
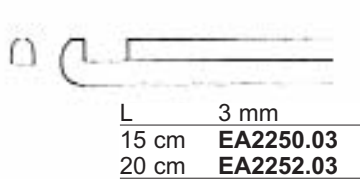

Intentionally left blank.

Intentionally left blank.

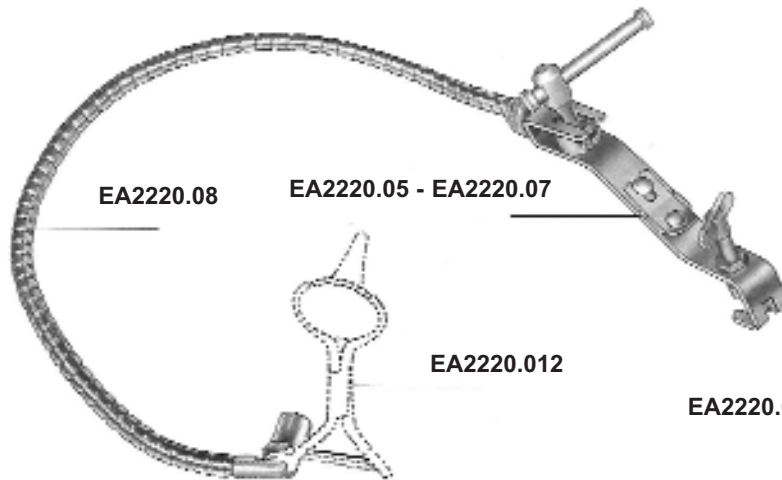

EA2220.08 Flexible arm only
 Spannarm allein
 Bras flexible seul
 Brazo flexible suelto
 Braccio flessibile solo

EA2220.12 Ear specula holder only
 Ohrtrichterhalter allein
 Support pour spéculum auriculaire
 Soporte para espéculo de oídos
 Sostegno per specolo auricolare

EA2220.06 Fixation bases for skull or rigid holding arm
EA2220.05 Fixiervorrichtungen für Schädel oder Starrarm
EA2220.07 Bases pour fixation au crâne ou au bras rigide
 Fijadores para fijación al cráneo o al brazo rígido
 Fissatori per fissaggio al cranio o al braccio rigido



EA2220.05

EA2220.05 Fixation base for 1 arm at skull
 Fixiervorrichtung am Schädel für 1 Arm
 Base de fixation pour 1 bras au crâne
 Fijador para 1 brazo al cráneo
 Fissatore per 1 braccio al cranio



EA2220.06

EA2220.06 Fixation base for 2 arms at skull
 Fixiervorrichtung am Schädel für 2 Arme
 Base de fixation pour 2 bras au crâne
 Fijador para 2 brazo al cráneo
 Fissatore per 2 bracci al cranio

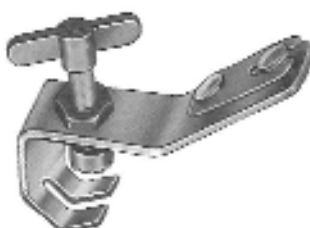

EA2220.07

EA2220.07 Fixation base for 1 arm at rigid arm
 Fixiervorrichtung am Starrarm für 1 Arm
 Base de fixation pour 1 bras au bras rigide
 Fijador para 1 brazo al brazo rígido
 Fissatore per 1 braccio al braccio rigido

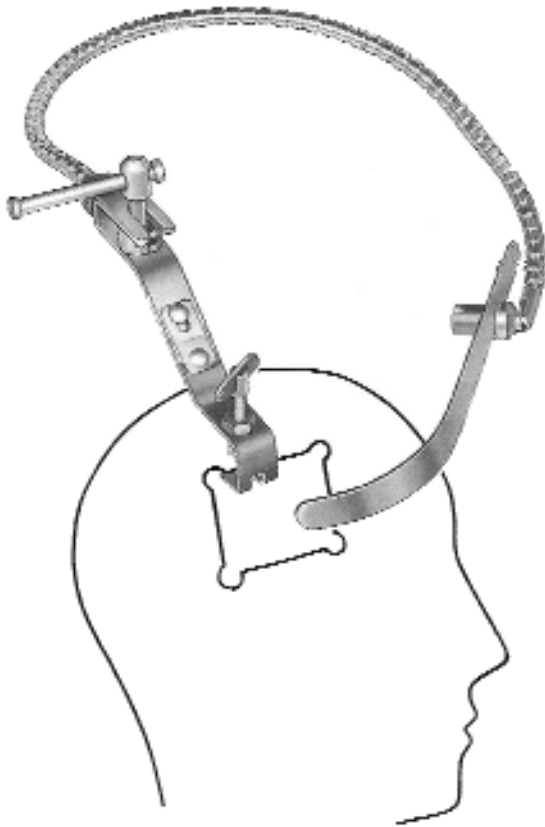

EA2221.00

Hirnspatelhalter, selbsthaltend, flexibel,
 für flache Spatel,
 mit 1 Spannarm, komplett, bestehend aus:
EA2220.05, EA2220.08, EA2220.09

Brain retractor, self retaining, flexible,
 for flat spatula
 with 1 flexible arm, complete, consisting of:
EA2220.05, EA2220.08, EA2220.09

Ecarteur autostatique, flexible,
 pour des spatules plates,
 avec un bras flexible, complet, composé de:
EA2220.05, EA2220.08, EA2220.09

Separador autorretentivo, flexible
 para espátulas llanas,
 con 1 brazo flexible, completo, compuesto de:
EA2220.05, EA2220.08, EA2220.09

Divaricatore autostatico, flessibile,
 per spatole piatte,
 con 1 braccio flessibile, completo, composto da:
EA2220.05, EA2220.08, EA2220.09

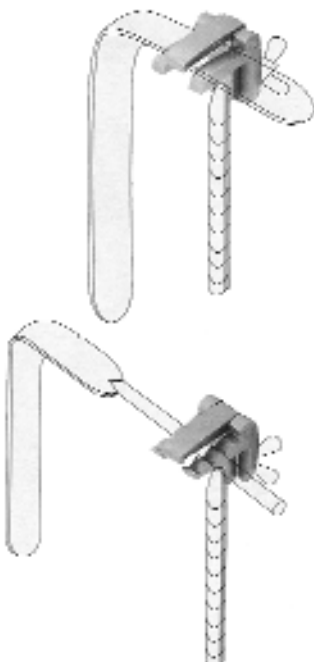

EA2220.09 Holder for flat brain spatula
 Halter für flache Hirnspatel
 Support pour des spatules plates
 Soporte para espátulas llanas
 Sostegno per spatole piatte

EA2220.10 Holder for brain spatula with round stem
 Halter für Hirnspatel mit rundem Schaft
 Support pour des spatules a tige ronde
 Soporte para espátulas con vástago redondo
 Sostegno per spatole con asta rotonda

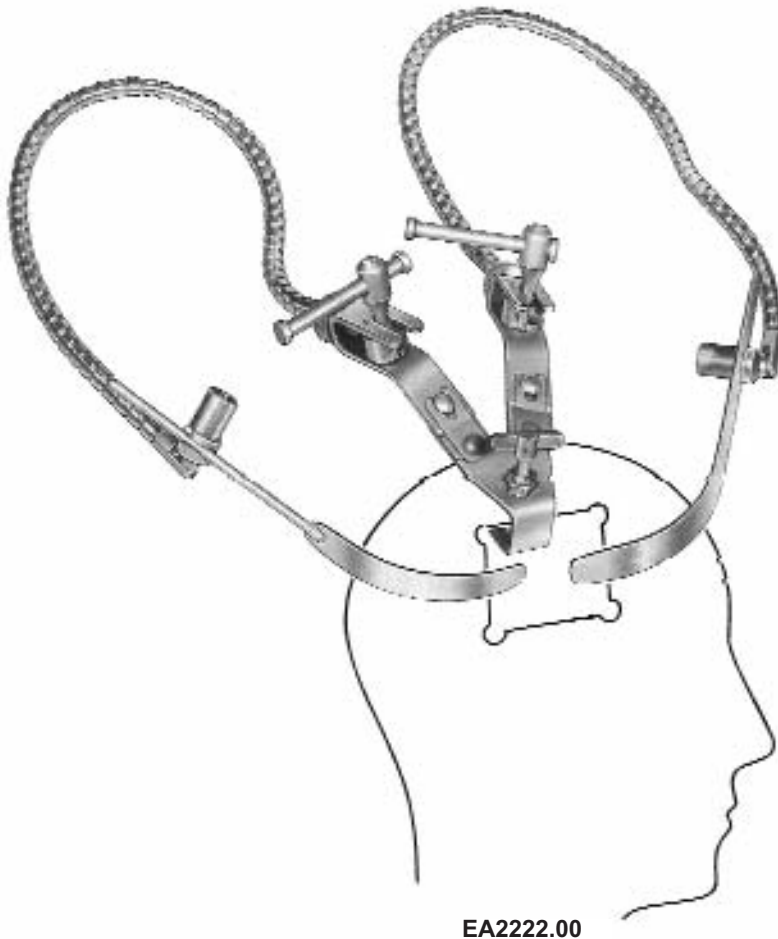

EA2222.00

Hirnspatelhalter, selbsthaltend, flexibel,
für flache Spatel,
mit 2 Spannarmen, komplett, bestehend aus:
2 x EA2220.08, EA2220.06, 2 x EA2220.09

Brain retractor, self retaining, flexible,
for flat spatula,
with 2 flexible arms, complete, consisting of:
2 x EA2220.08, EA2220.06, 2 x EA2220.09

Ecarteur autostatique, flexible,
pour des spatules plates,
avec 2 bras flexibles, complet, composé de:
2 x EA2220.08, EA2220.06, 2 x EA2220.09

Separador autorretentivo, flexible,
para espátulas llanas,
con 2 brazos flexibles, completo, compuesto de
2 x EA2220.08, EA2220.06, 2 x EA2220.09

Divaricatore autostatico, flessibile,
per spatole piatte
con 2 bracci flessibili, completo, composto da:
2 x EA2220.08, EA2220.06, 2 x EA2220.09

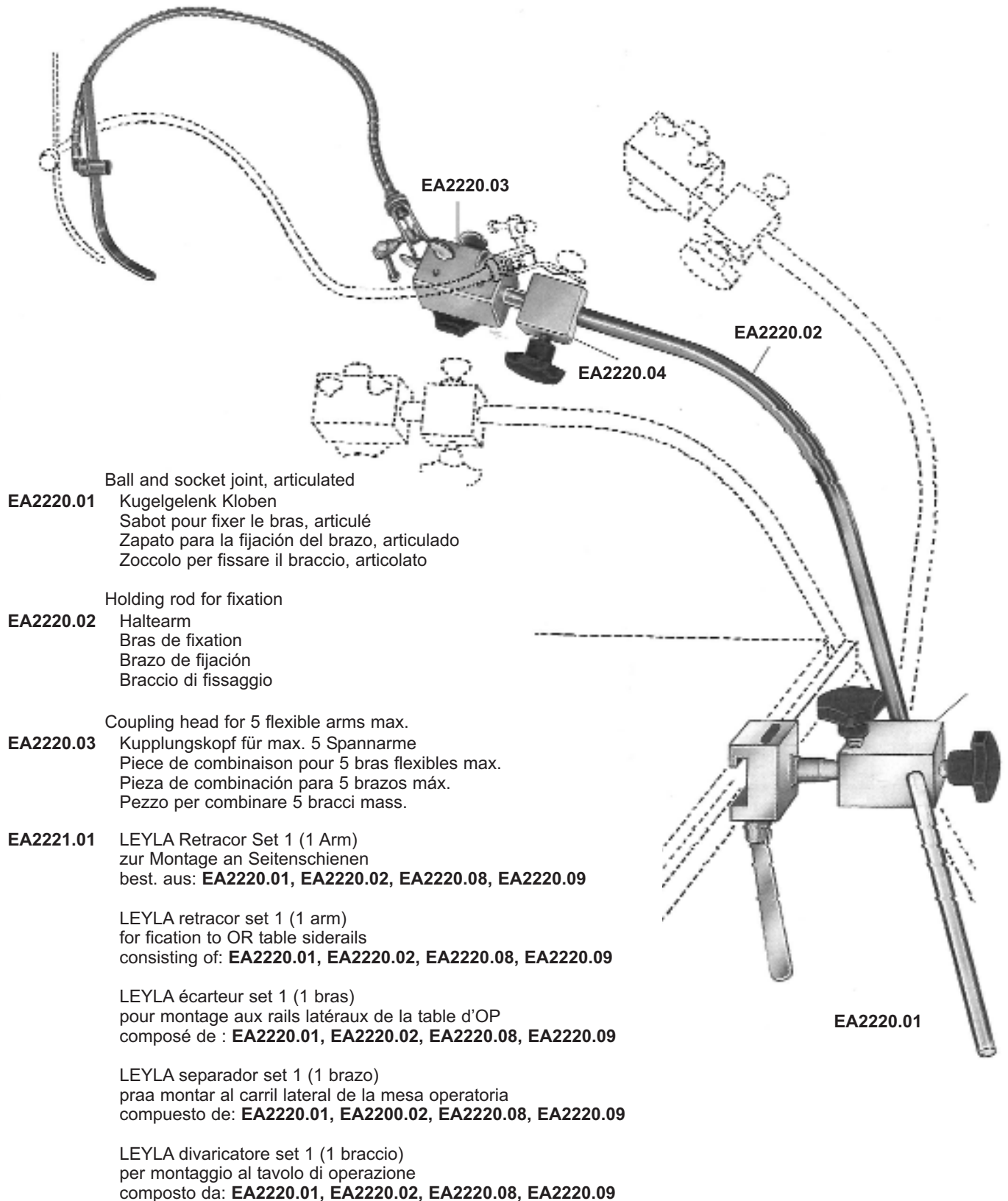

- EA2220.01** Ball and socket joint, articulated
 Kugelgelenk Kloben
 Sabor pour fixer le bras, articulé
 Zapato para la fijación del brazo, articulado
 Zoccolo per fissare il braccio, articolato
- EA2220.02** Holding rod for fixation
 Haltearm
 Bras de fixation
 Brazo de fijación
 Braccio di fissaggio
- EA2220.03** Coupling head for 5 flexible arms max.
 Kupplungskopf für max. 5 Spannarme
 Pièce de combinaison pour 5 bras flexibles max.
 Pieza de combinación para 5 brazos máx.
 Pezzo per combinare 5 bracci mass.
- EA2220.03** Coupling head rotatable
 Kupplungskopf drehbar
 Pièce de combinaison rotative
 Pieza de combinación giratoria
 Pezzo per combinare girevole
- EA2222.02** LEYLA Retractor Set 2 (2 Arme) zur Montage an Seitenschiene
 best. aus: **EA2220.01, EA2220.02, EA2220.03, EA2220.04**
 2 x **EA2220.07, 2 x EA2220.08, 2 x EA2220.09**
- LEYLA retractor set 2 (2 arms for fixation to OR table siderails
 consisting of: **EA2220.01, EA2220.02, EA2220.03, EA2220.04**
 2 x **EA2220.07, 2 x EA2220.08, 2 x EA2220.09**
- LEYLA écarteur set 2 (2 bras) pour montage aux rails latéraux
 de la table d'OP
 composé de : **EA2220.01, EA2220.02, EA2220.03, EA2220.04**
 2 x **EA2220.07, 2 x EA2220.08, 2 x EA2220.09**
- LEYLA separado set 2 (2 brazos) para montar al carril lateral de la
 mesa operatoria
 compuesto de: **EA2220.01, EA2220.02, EA2220.03, EA2220.04**
 2 x **EA2220.07, 2 x EA2220.08, 2 x EA2220.09**
- LEYLA divaricatore set 2 (2 bracci) per montaggio
 al tavolo di operazione
 composto da: **EA2220.01, EA2220.02, EA2220.03, EA2220.04**
 2 x **EA2220.07, 2 x EA2220.08, 2 x EA2220.09**

